

**Compaction
with
Roller Presses**

**Kompaktieren
mit
Walzenpressen**

Köppern

Köppern Know-How – Compaction / Granulation

Köppern Know-How – die Pressgranulierung



*Compaction tests
in Köppern's pilot plant
Kompaktierungsversuche in
unserem Technikum*

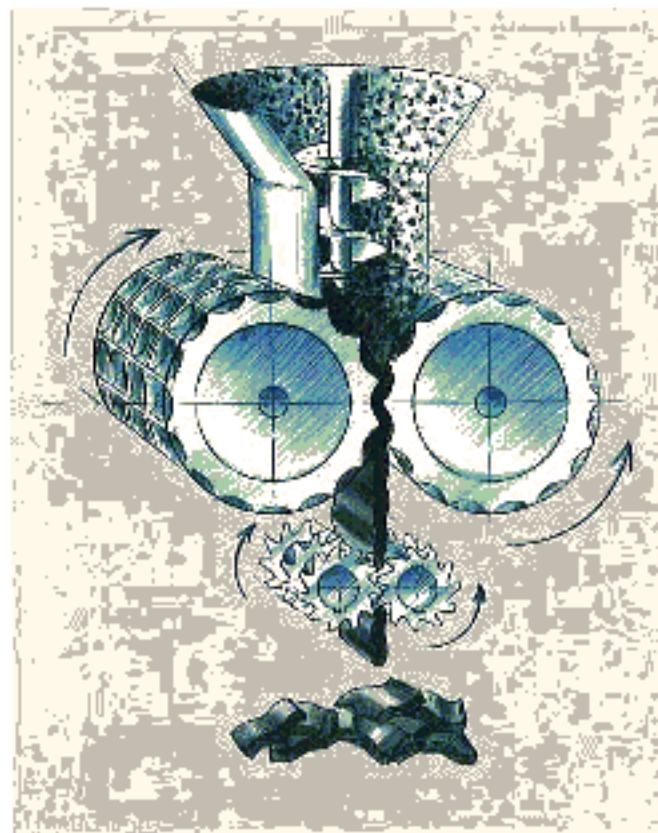

Premixed particulate material is compacted in a roller press into sheets (flakes), pre-crushed, granulated, and screened.

Das gemischte Feingut wird in einer Kompaktieranlage zu Schülpen verpresst, vorzerkleinert, zu Granulat zerkleinert und klassiert.



Partial list of materials commonly granulated by compaction:

- ammonium sulphate
- calcium cyanamide
- ceramic materials
- NPK fertilizers
- potash
- roasted pyrite
- salts
- sodium carbonate
- sodium sulphate
- thomas potash

Auswahl von Stoffen, die zu Pressgranulaten verarbeitet werden:

- Ammoniumsulfat
- Kali
- Kalkstickstoff
- Keramikmaterial
- Kiesabbrände
- Natriumsulfat
- NPK-Dünger
- Salze
- Soda
- Thomaskali

Köppern Roller Presses – Designed for Top Performance

Köppern-Walzenpressen – Spitzenleistung bis ins Detail

*Köppern Roller Presses
are available
for all capacity ranges*

*Köppern-Walzenpressen
für alle Leistungsbereiche*

press type Pressentype	Köppern Roller Presses capacity ranges							max. pressing force (kN) max. Presskraft (kN)
	Köppern-Walzenpressen Leistungsbereiche				Leistung t/h			
	0	20	40	60	80	100	120	
40	■							1600
52		■						2600
60			■					3750
72				■				5300
92					■			8650
500						■		10.400

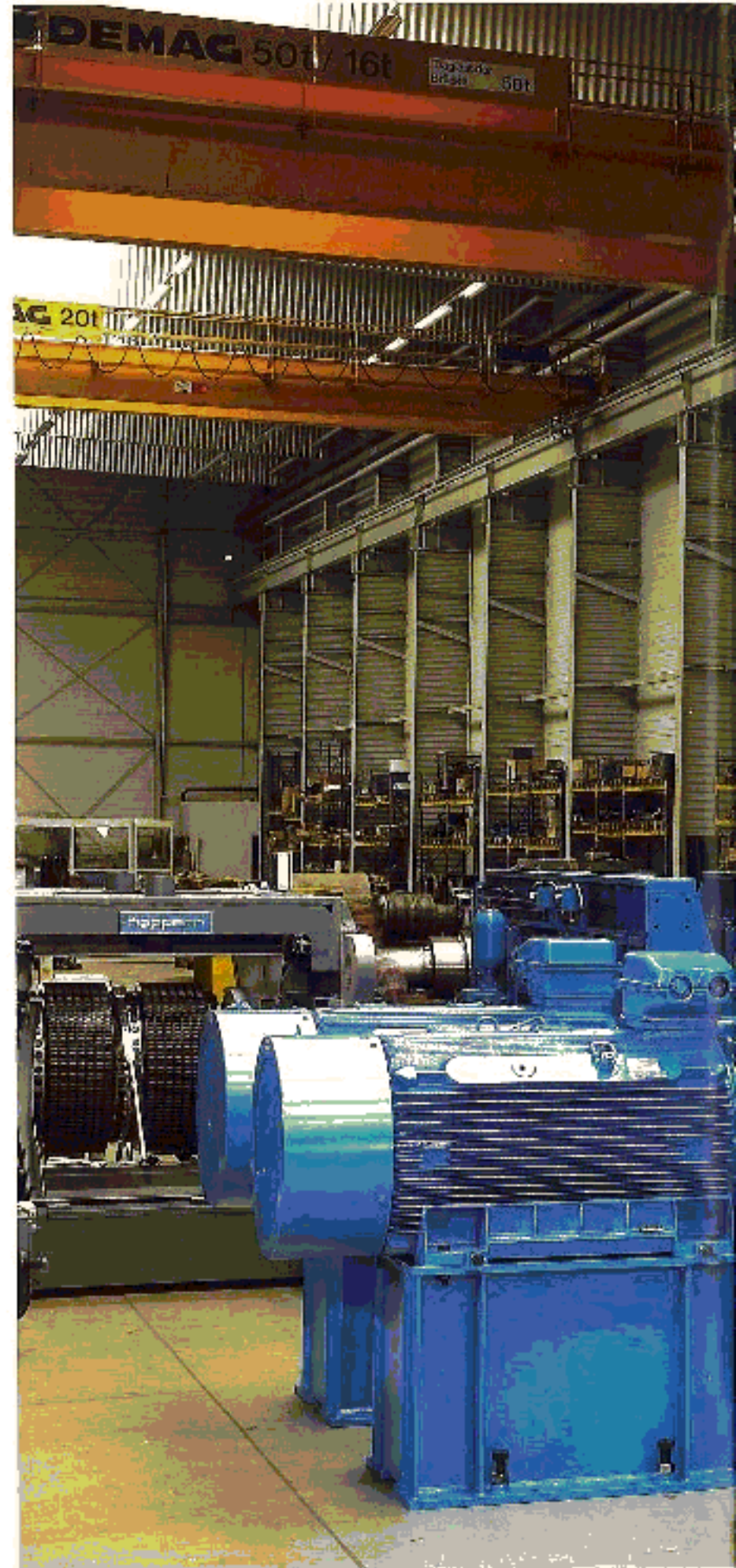

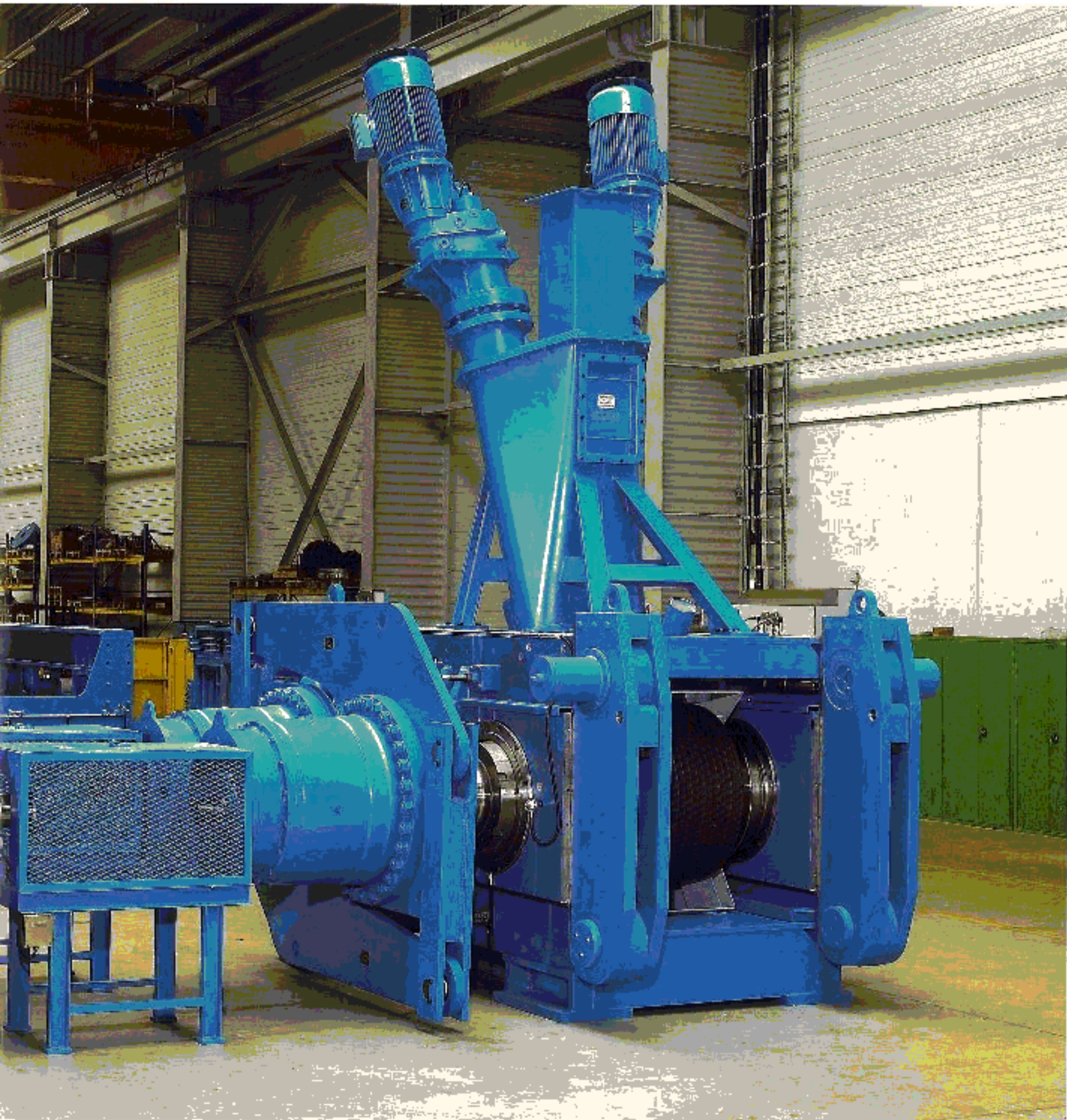

*Roller press for compaction
Walzenpresse für die Kompaktierung*

Köppern

Köppern
Possesses Special Know-How
Including Plant Engineering

Köppern
– Spezialkenntnisse
bis zum Anlagenbau

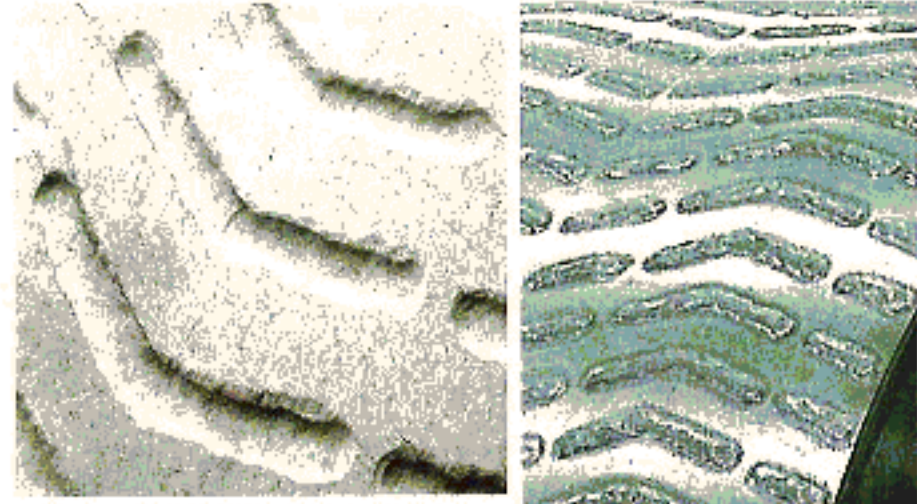

Roller with hard facing

Gepanzerte Walzenoberfläche

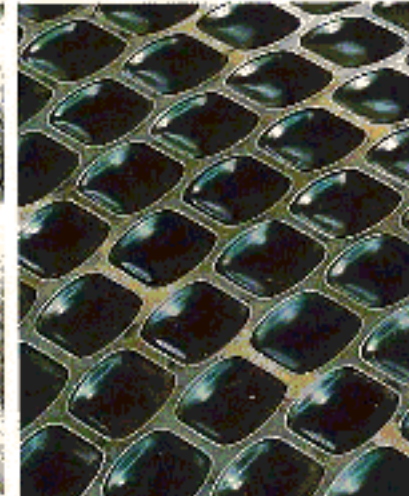
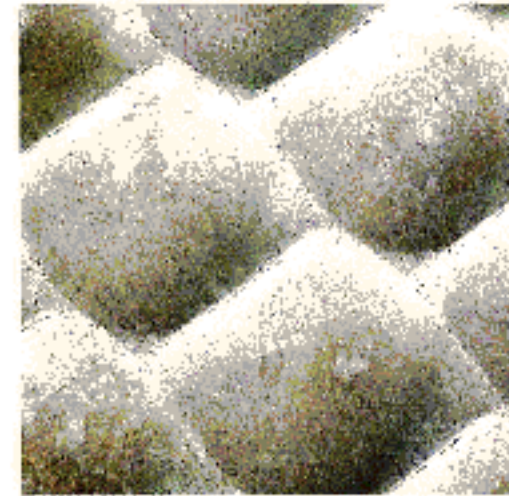

Köppern fertilizer compaction plant
Köppern Dünger-Kompaktieranlage

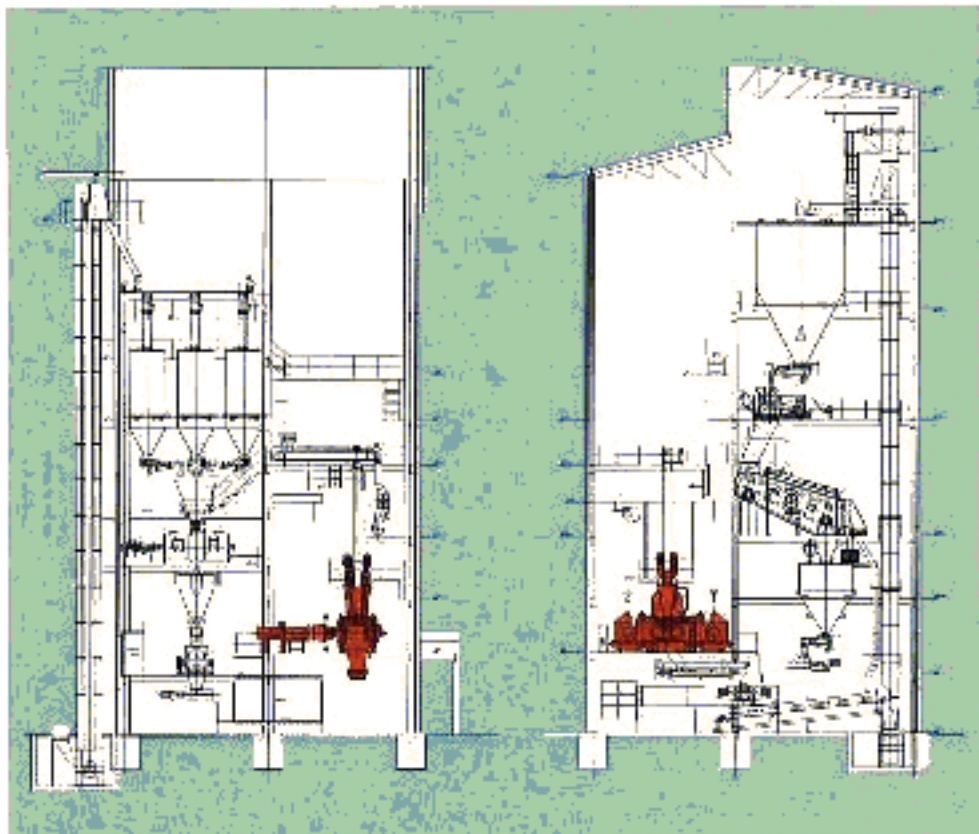

Köppern fertilizer compaction plant

Köppern Dünger-Kompaktieranlage

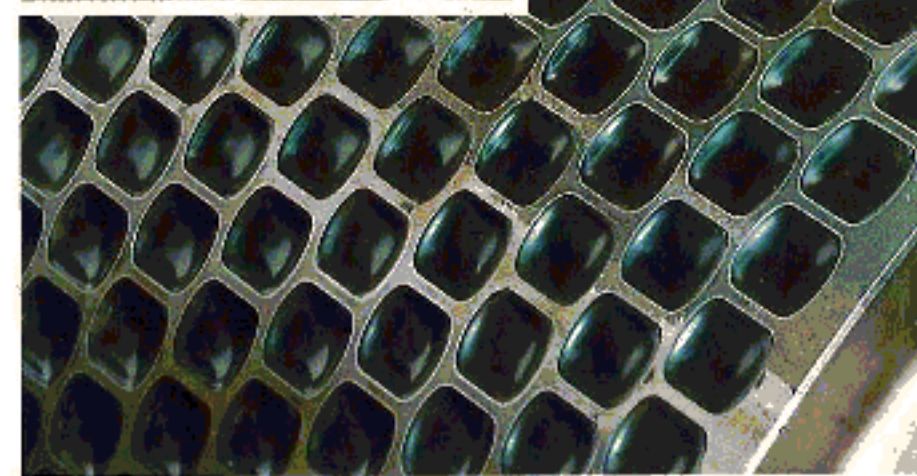

Profiled roll tyre

Profiliertes Ring



Material feeder

Materialzuteiler

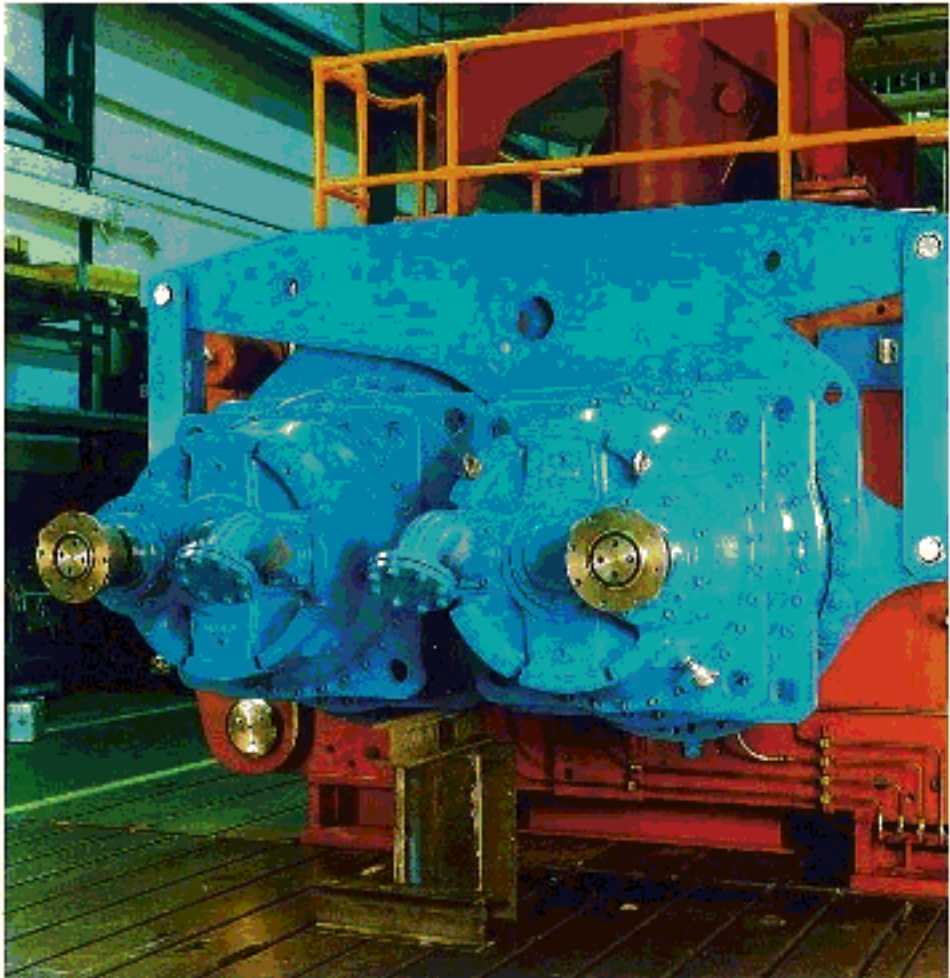

Planetary gears

Planetengetriebe

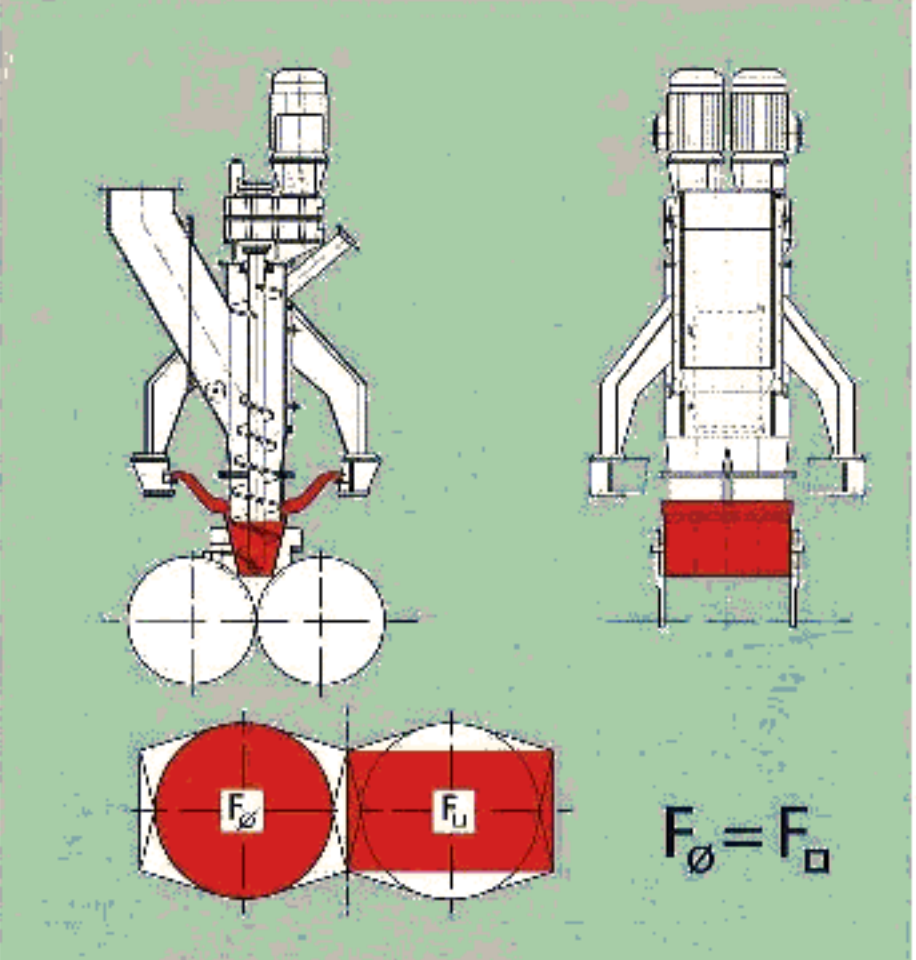

Screw feeder with transition piece

Schnecke mit Übergangstück

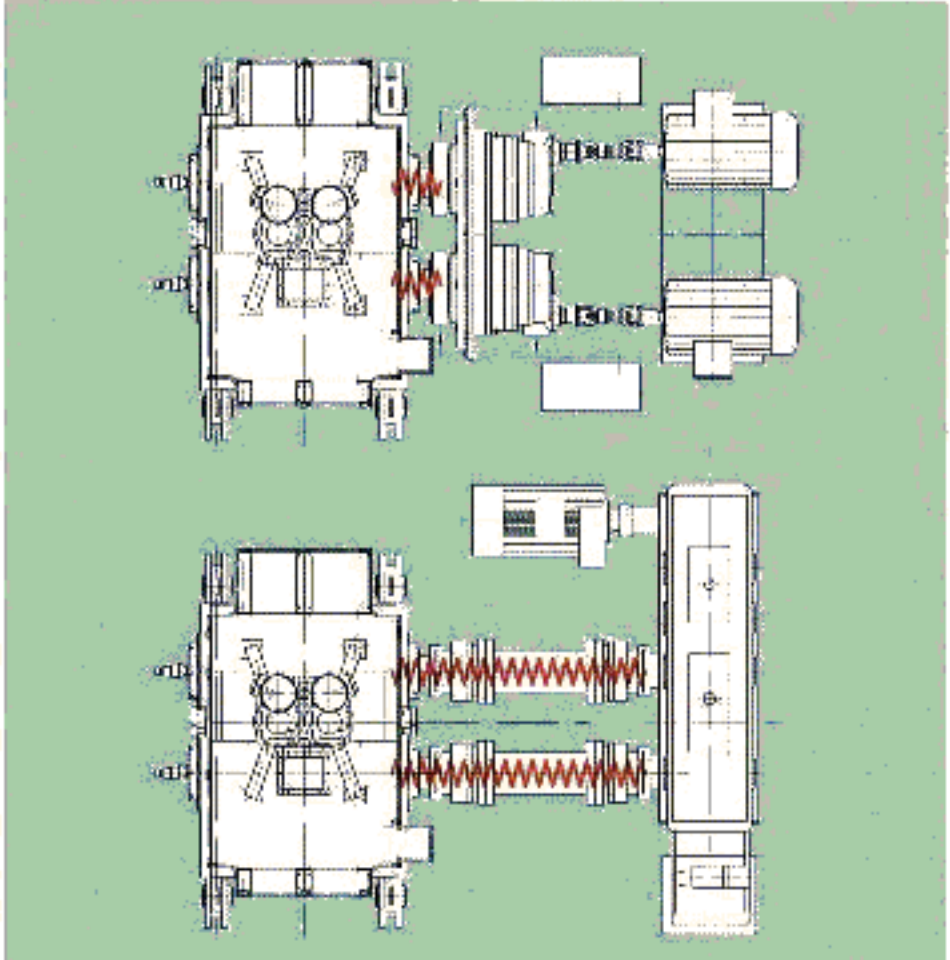

Comparison planetary- / double shaft drive

Vergleich Planeten- / Doppelwellenantrieb

Maschinenfabrik Köppern GmbH & Co. KG

Königsteiner Straße 2
45529 Hattingen/Ruhr
Tel.: ++49/2324/207-0
Fax: ++49/2324/207-207
E-mail: info@koeppern.com
www.koeppern.com
Germany

Köppern Entwicklungs-GmbH

Königsteiner Straße 2
45529 Hattingen/Ruhr
Tel.: ++49/2324/207-0
Fax: ++49/2324/207-301
E-mail: info@koeppern.com
www.koeppern.com
Germany

Maquinarias Koeppern Venezuela C.A.

UD-321, Parcela 08-08, Edificio Koeppern
Zona Industrial Matanzas Sur
Apartado Postal 766
8015-A Puerto Ordaz
Tel.: ++58/286/9941792
Fax: ++58/286/9941687
E-mail: mkv@cantv.net
Venezuela

Koeppern Equipment, Inc.

2725 Water Ridge Parkway
Six Lake Pointe Plaza
Charlotte NC 28217
Tel.: ++1/704/357-3322
Fax: ++1/704/357-3350
E-mail: moreinfo@koeppernusa.com
USA

Koeppern Machinery Australia Pty. Ltd.

73 Pavers Circle
Perth - Malaga, WA 6090
Tel.: ++61/8/9248 4170
Fax: ++61/8/9248 4176
E-mail: info@koeppern.com.au
Australia

Koeppern Maco Services Pvt. Ltd.

Flat No. 6c, 6th Fl. Sukhsagar Apartments
2/5 Sarat Bose Road
Calcutta 700 020
Tel.: ++91/33/2455 6116
Fax: ++91/33/2476 9052
E-mail: info@koeppern-kmspl.com
India

Köppern Aufbereitungstechnik GmbH & Co. KG

Agricolastr. 24
09599 Freiberg
Tel.: ++49/3731/2018-0
Fax: ++49/3731/2018-20
E-mail: info@koeppern-kat.de
Germany

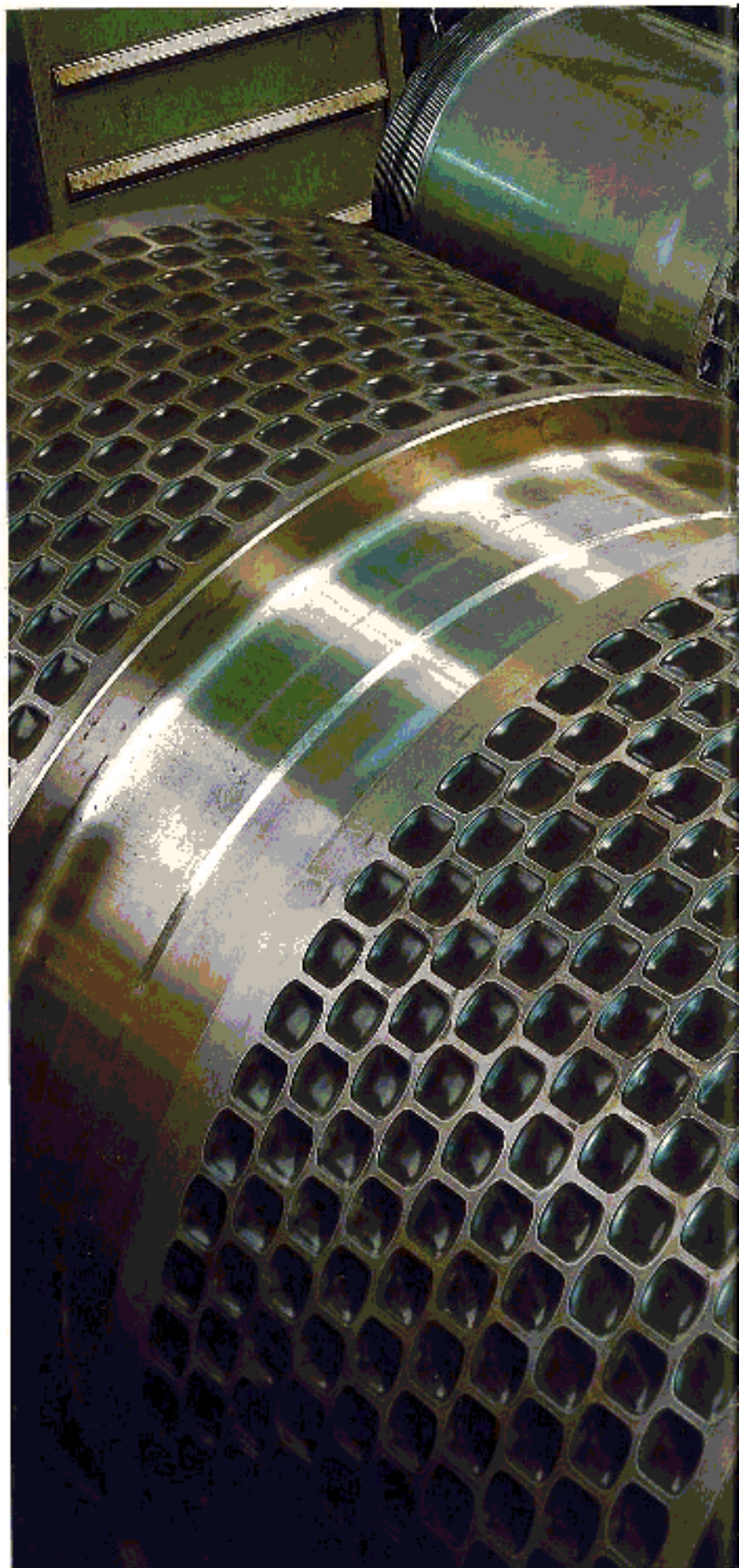

Technische Änderungen vorbehalten. Subject to alterations owing technical advances.
© 2005 Maschinenfabrik Köppern GmbH & Co. KG.

